

# Masthead Float Kit

Version 1



Fit the masthead float before stepping the mast in the boat.

## Tools Required

Drill  
5mm drill bit  
Allen key set  
Pencil - optional  
Pozidrive screw driver  
Pop rivet gun  
4mm drill bit  
Loctite

## Kit Contents

1 x Mast head float  
2 x Metal brackets (port and starboard)  
2 x Plastic cheek pads  
4 x M6 x 12 machine screw  
6 x 8 x 1/2 self tapper screw  
6 x M5 small washer  
8 x Monel Poprivets

PARTS LIST			
ITEM	SUPPLIER PART#	QTY	COMMENTS
1	379-468-01	1	Mast Float Adaptors
2	558-457	1	Masthead Float Bracket- RS STBD
3	558-456	1	Masthead Float Bracket- RS PORT
4	171-095	6	5/16" Tap Propan Hex Bolt / Z AB
5	169-098	8	Pop Rivet U10x50 (04.8x12.7)MNL
6	597-406	1	Masthead Float Base
7	166-409	6	Washer MS ST/A
8	155-005	4	Screw M4x5.6xZ

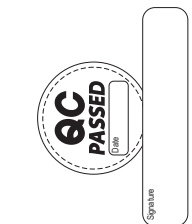
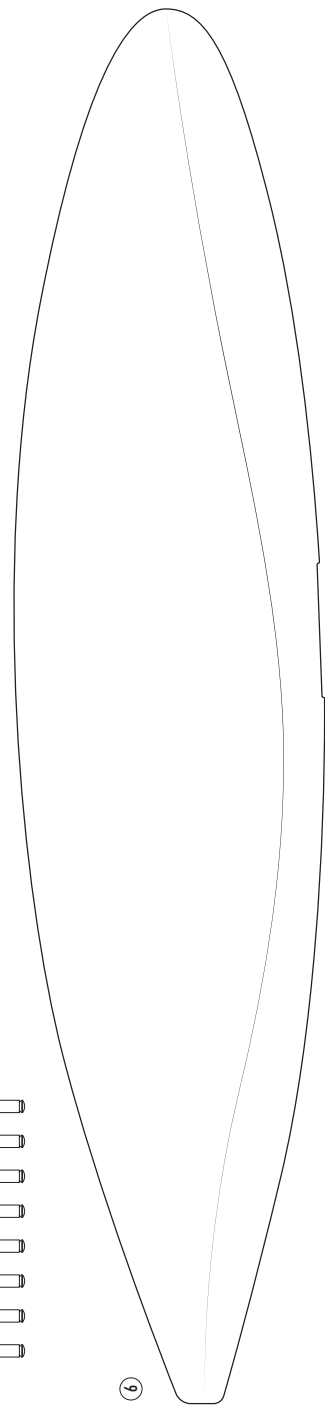
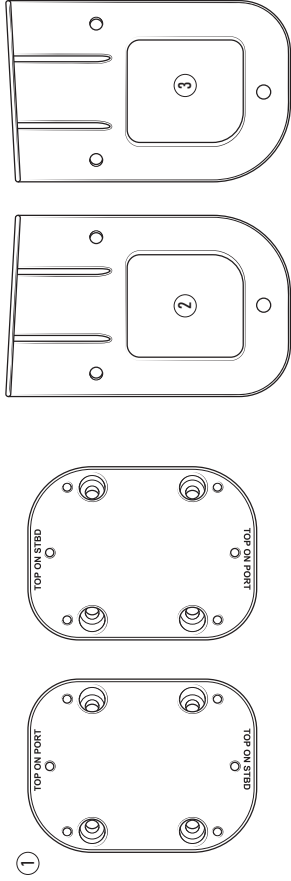
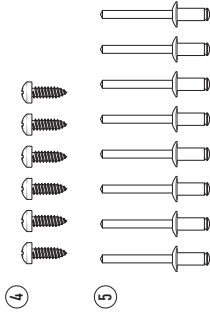

REV	DETAIL	BY	DATE	CHNG
1	1st Edition	M. J. Perry	18/10/2022	
NAME		SHIPYARD		
FACTORY		OFFICE		
DRW No.	SIZE	NTS		
DRW No.	SIZE	NTS		
THIS DRAWING IS THE PROPERTY OF OCEAN PLAY SAILING LTD. IT IS NOT TO BE REPRODUCED OR TRANSMITTED IN ANY FORM OR BY ANY MEANS, ELECTRONIC OR MECHANICAL, WITHOUT THE WRITTEN PERMISSION OF OCEAN PLAY SAILING LTD.				
FILE	X-1020H - Ocean Play BUS Float Set.dwg	Sheet No.	1 of 1	
		AS		

# Attaching the Masthead Float

1. Attach the brackets to the masthead float using the four bolts provided.



The brackets are not the same and are labelled port and starboard. Make sure you use the correct bracket on each side.



Add a little Loctite to the threads of the screw.

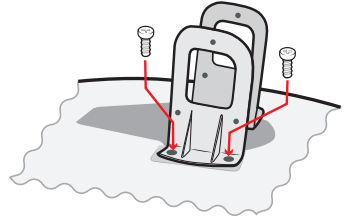

2. Fix the cheeks to the brackets.

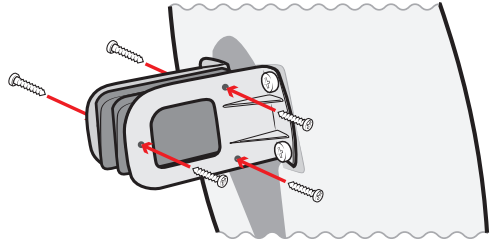

Position the assembly on the mast in the correct position and draw around the cheeks with a pencil.

Remove the cheeks from the bracket.

Using the pencil marks on the mast position the plastic cheeks.

Mark and drill the mast through the 5mm holes in the cheeks.

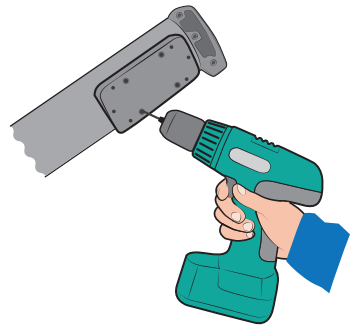

Fit the cheeks with 4 x pop rivets.

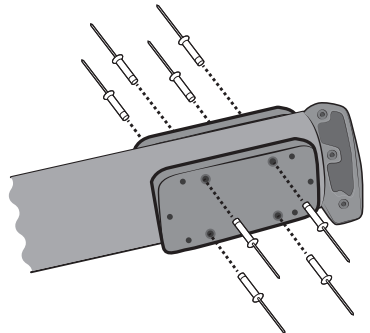

3. Make sure you have lined up the up the holes on the bracket, mounting plate and mast, run the 4mm drill bit through the holes, then attach the bracket using the 6 screws provided.



Add a little Loctite to the threads of the screws first.

